

Coffee System TANGO ACE, 1 group full- automatic machine, Steamair

ITEM # _____

MODEL # _____

NAME # _____

SIS # _____

AIA # _____

602555 (TANGOACEISA)

Full-automatic machine, 1 group, 220x40 ml espresso cup/hr, 6,5 liter steam/coffee boiler, 1x1,7 kg and 1x1,2 kg coffee hopper, programmable water, Steamair

Short Form Specification

Item No.

The super automatic coffee machine Tango® Ace impresses its users with an exceptional result in every cup, and the quality of its equipment makes it a highly reliable choice for demanding professional use.

The Tango® Ace comes in 3 different colors: shiny white, glossy black and brushed stainless steel, fitted with a new 7" color touch screen user interface. This full automatic coffee machine has a 48 drinks menu, all customizable and comprehensive with the addition of the Cappuccinatore device to process fresh into specialty coffee drinks as cappuccino, latte, mocha...

Delivery capacity:

Espresso 40ml : 220 cups/h

Lungo 100ml : 150 cups/h

Hot water : 30 L/h

Main Features

- 1 group full-automatic machine.
- 6.5 liter steam/coffee boiler.
- Auto cleaning program.
- Steamair milk auto-frother programmable outlet.
- The super automatic coffee machine Tango® Ace impresses its users with an exceptional result in every cup, and the quality of its equipment makes it a highly reliable choice for demanding professional use.
- The Tango® Ace comes in 3 different colors: shiny white, glossy black and brushed stainless steel, fitted with a new 7" color touch screen user interface. This full automatic coffee machine has a 48 drinks menu, all customizable and comprehensive with the addition of the Cappuccinatore device to process fresh into specialty coffee drinks as cappuccino, latte, mocha...
- Delivery capacity:
Espresso 40ml: 220 cups/h
Lungo 100ml: 150 cups/h
Hot water: 30 L/h

Construction

- 2 coffee grinders (1 x 1,7 kg & 1 x 1,2 kg coffee hoppers).
- LCD Touchscreen.
- PID (proportional-integral-derivative) Temperature control: a precise controller algorithm system that gives consistency and accuracy to brewing temperature management system.

Optional Accessories

- Side milk refrigerator 8 liter nominal capacity for up to 4 liter milk containers PNC 871014
- Side milk refrigerator 8 liter nominal capacity for up to 4 liter milk containers with digital display PNC 871015
- TANGO hotel/breakfast service kit PNC 871022
- Coffee ground direct discharge chute PNC 871023
- Raised feet kit PNC 871041

APPROVAL: _____

Front

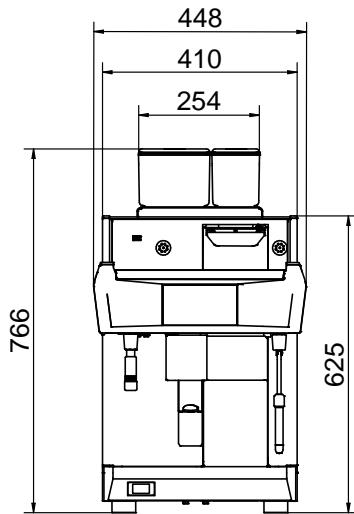

Side

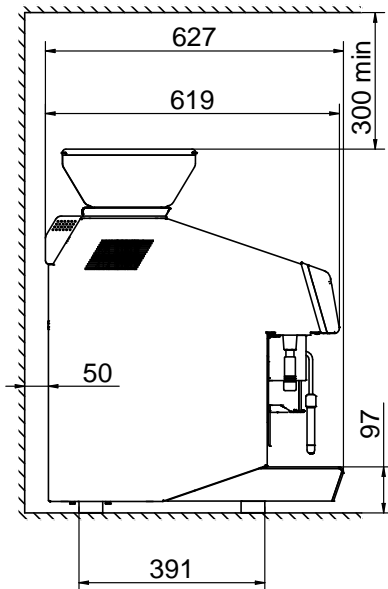

Top

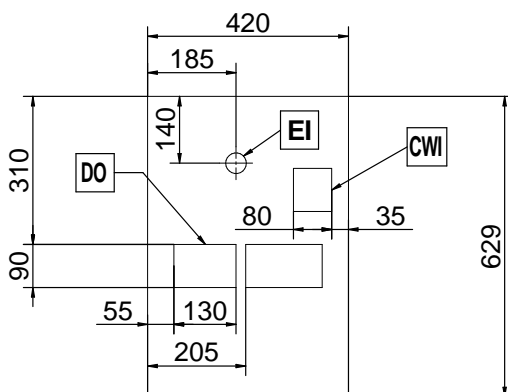

Electric

Supply voltage:

602555 (TANGOACE1SA) 400 V/3N ph/50 Hz

Electrical power max.:

5.2 kW

Plug type:

Cable without plug

Water:

Cold water temperature

(min/max): 5 / 60 °C

Key Information:

External dimensions, Width: 448 mm

External dimensions, Depth: 627 mm

External dimensions, Height: 766 mm

Net weight: 103 kg

Shipping volume: 0.69 m³

Sustainability

Current consumption: 14.5 Amps